



- **Estores:** • Alumínio • Térmicos • PVC • Compactos • Rolo • Brisas
- Laminados • Verticais • Painel Japonês • Mosquiteiras
- **Motores** • **Asas de Avião** • **Portões** • **Acessórios**

**Catálogo Geral**

Compactos





Janelas de estores compactos, é uma forma completa de estore para janelas sem caixa de reboco, que permitem um isolamento atmosférico perfeito, ideal para prédios antigos.

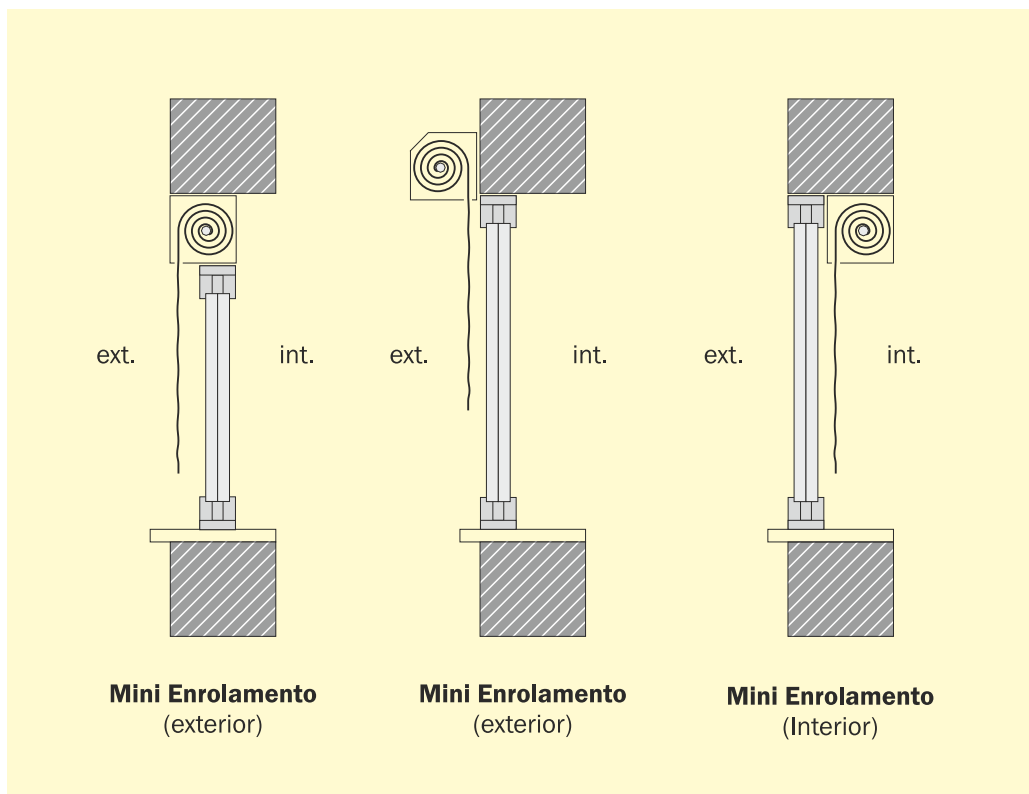

Esquema de Montagem

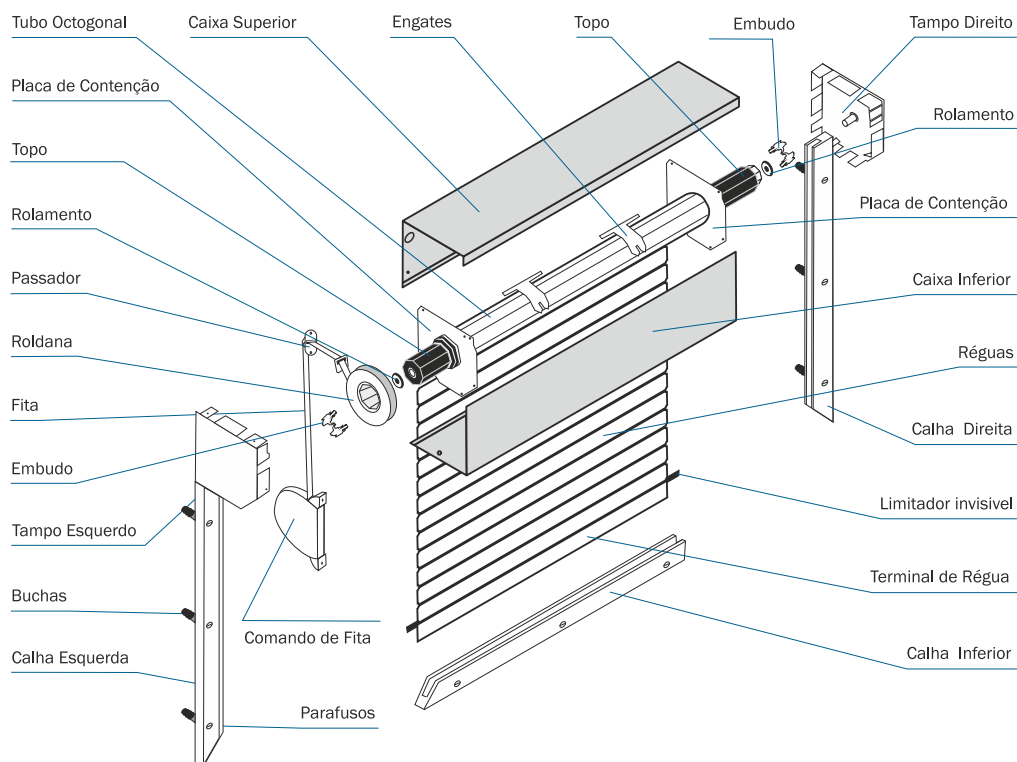

**Régua Alumínio Termo-lacada**  
M 45

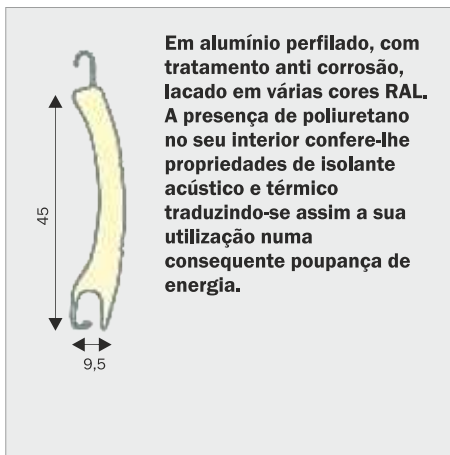

**Régua Alumínio Termo-lacada**  
Alugix de 50 e 55

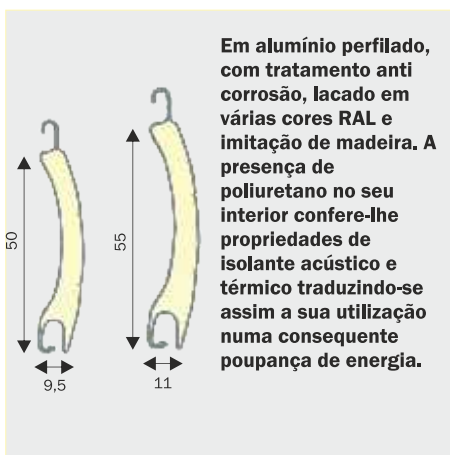

**Régua PVC Minor**  
de 53 e 39

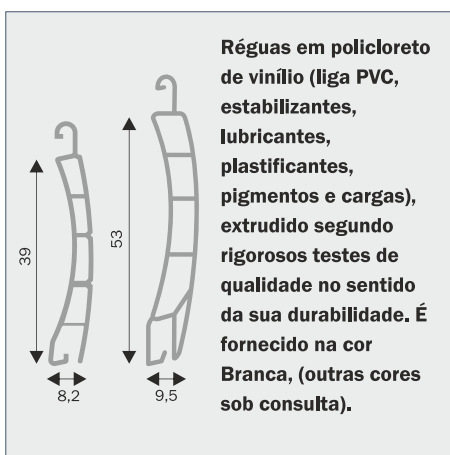

**Clarabóia**

Sempre c/ 2 cxs.  
1 - Motor  
2 - Mola

**Régua aconselhadas para todo tipo de estore compacto**

Ver características técnicas das régua nas páginas dos térmicos e PVC

**Caixa Alumínio Winblock**  
Redonda



**Caixa 2 partes 45°**

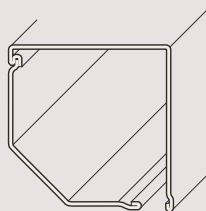

137  
165  
180  
205  
250  
300  
400

**Caixas WINBLOCK**

As Caixas Winblock fabricadas em alumínio extrusionado. Podem ser aplicadas numa vasta gama de combinações alumínio PVC e cores RAL ou imitação de madeira  
(Consultar o nosso Catálogo de cor)

**Caixa Alumínio**  
Quadrada 4 partes 90°



137 / 165 / 180 / 205

**Caixa Alumínio**  
45°

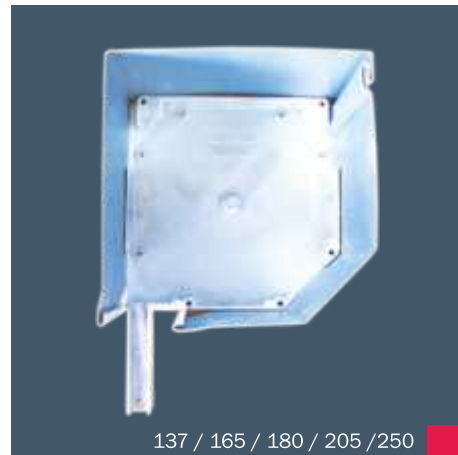

137 / 165 / 180 / 205 / 250

**Caixa Alumínio**  
Winblock Quinada



200 / 230

**Caixa Alumínio**  
Winblock Redonda



200 / 230

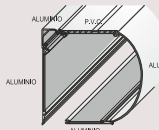
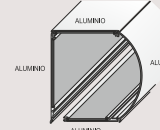
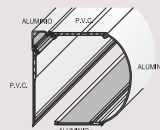
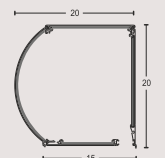
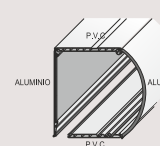
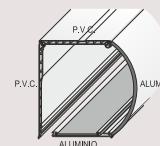
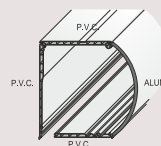
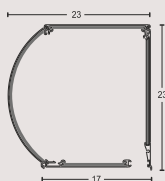

**Caixa PVC Corbox**



185

**Caixa PVC Eurodecor**



155 / 185 / 200

**Caixa PVC Winblock**  
Quinada



**Caixa PVC Quadrada**



155 / 185 / 200 / 220 / 290

**Caixa Decor Alumínio**  
Forrada a alumínio



185 (outras medidas sob consulta)

**Caixa 4 partes**

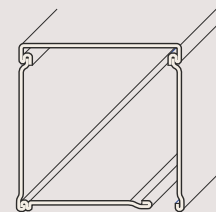

137  
165  
180  
205

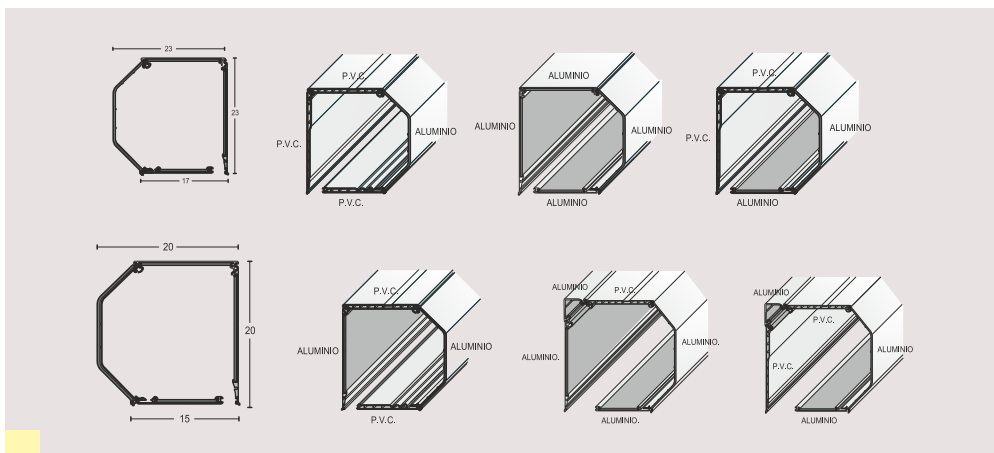

**Caixas EURODECOR**

As Caixas Eurodecor fabricadas em PVC de dupla parede podem ser conjugadas com PVC e Alumínio existem numa vasta gama de cores RAL (Consultar o nosso Catálogo de cor)



Tampos de caixas em alumínio extrudido  
Existem numa vasta gama de cores RAL  
(Consultar o nosso Catálogo de cor)

Caixa R/PVC



185

Caixa 90°



137 / 165 / 180 / 205

Caixa Alumínio 45°



137 / 165 / 180 / 205 / 250

Caixa PVC



155 / 185 / 200

Placas de Contenção 45°



137 / 165 / 180 / 205 / 250

Placas de Contenção



137 / 165 / 180 / 205

**Topo de 60**

para tubo de 60 e rolamento c/ furo de 12



**Roldana PVC**

c/ Rolamento



120 / 140 Fita de 14/18/20

**Tubo Octogonal**

Extensivo

**60**

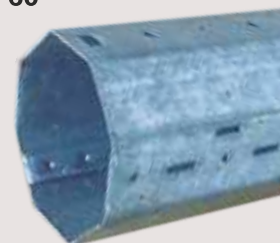

60x0,6

**50**



50x0,5

**42**

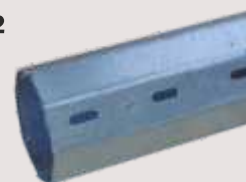

42x0,4

**Batentes**

de estore em PVC



**Topos de 42**

para tubo de 42 e rolamento c/ furo de 12



**Embudos**

Para Caixa de PVC e Alumínio



**Embudos de Roleta**

Para Caixa de Alumínio de 250/45



Produção própria.



**Mola de Segurança**  
para Compactos  
Régua de 45/55



**Engate Super**  
com régua de PVC



**Engate Misto Forrado**  
Régua de Compactos



**Comando de Fita (externo)**  
Fita de 14 e 18 Várias cores



**Comando de Fita (externo)**  
Fita de 14 e 18 Várias cores



**Comando de Fita (embutido)**  
Fita de 14 e 20 Várias cores



**Comando de Fita (embutido)**  
Fita de 14 e 18 Várias cores



**Comando de Fita (embutido)**  
Fita de 14 e 18 Várias cores



**Passadores**  
Fita de 14 e 20



**Passador**  
Fita de 14 e 20



**Passador**  
de mola para fio



**Trincador mod. B**



**Trincador mod. A**



**Fechadura de Segurança**  
Com chave (anti-roubo)



**Fio** n.º 2 / 3 / 4 / 5



**Pega de Estore**



**Patilha de Estore**



AZ 60

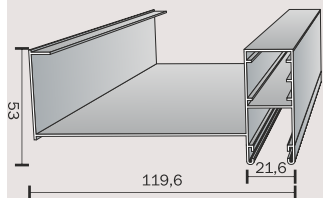

AZ 70

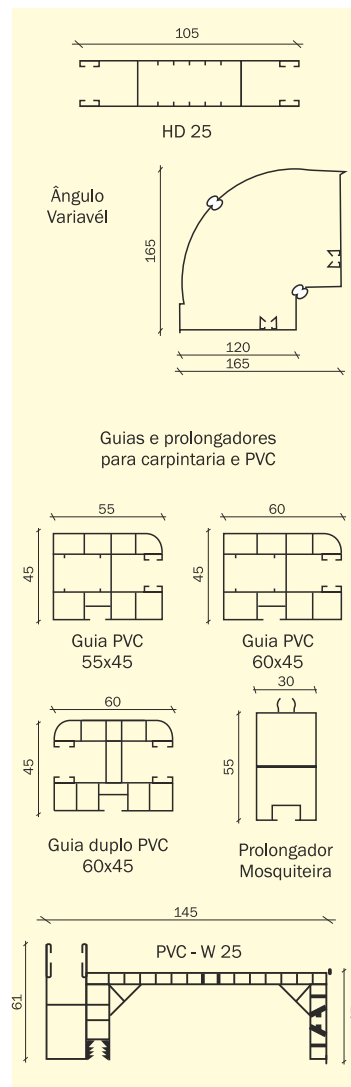
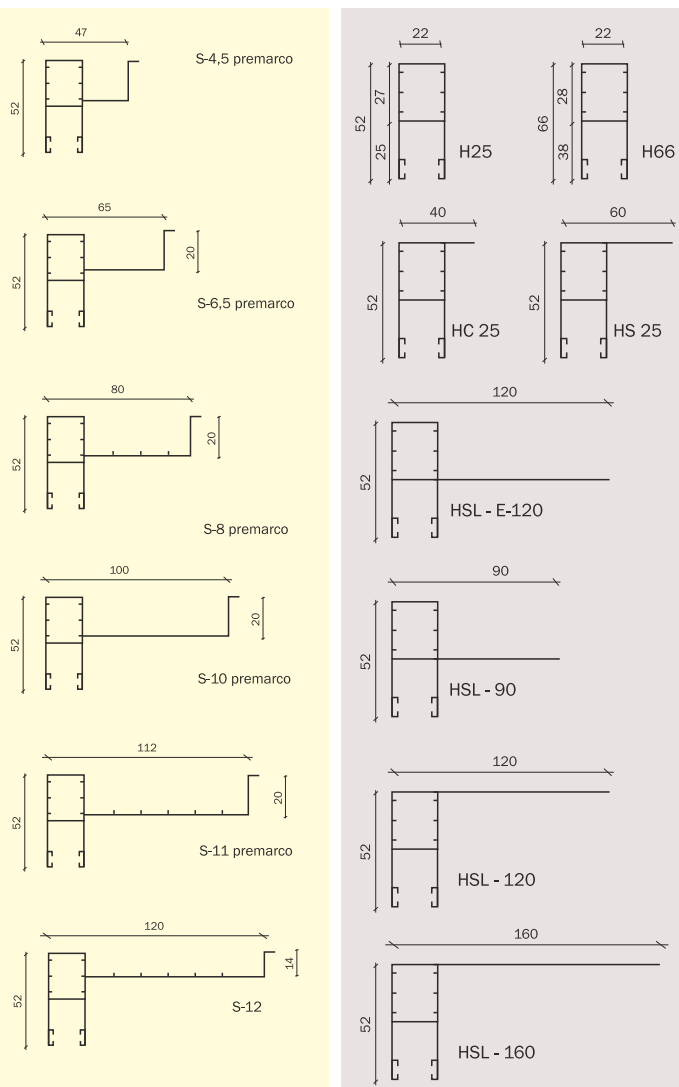
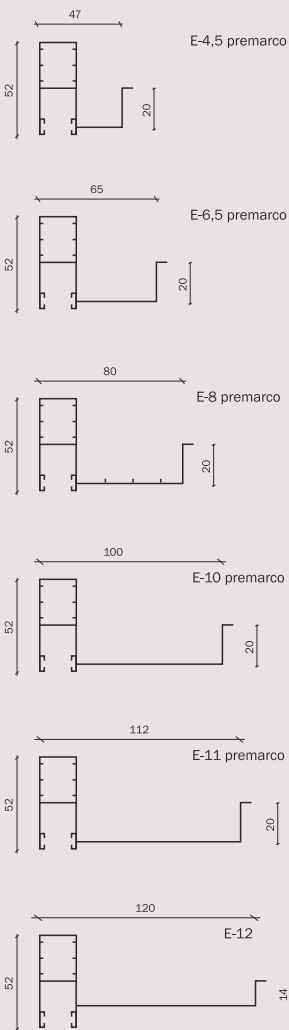
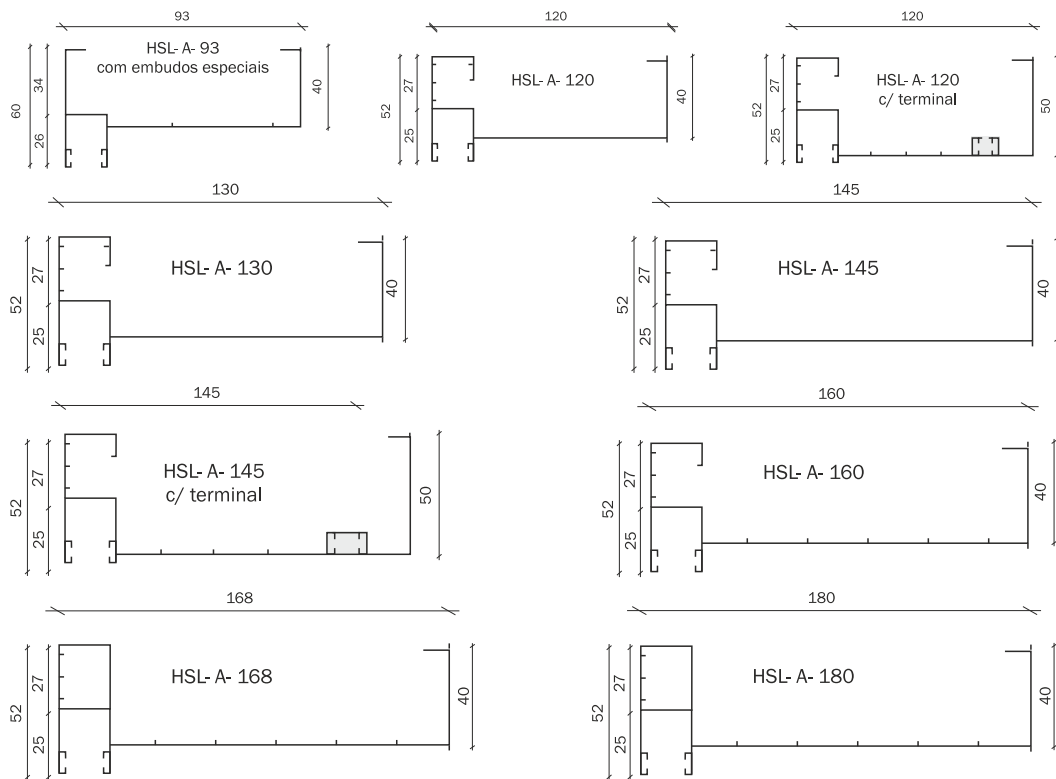
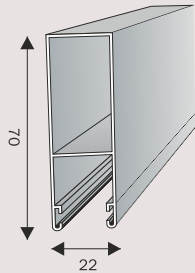



Venda e fabrico de todo tipo de Estores Interiores

**BRISOFLEX**

Norte



Fabrico de Brisas Solares e Tubo Octogonal



Fabrico de Régua Térmica e Lacagem

**BRISOFLEX**

Sul



Venda de todo tipo de Estores



Venda de todo tipo de Estores

Zona Industrial de Gandra | Rua da Indústria, 240  
4440-230 CAMPO VALONGO  
Tels. 224 159 958/9 | Fax 224 159 960  
E-mail: [estoreslimite@hotmail.com](mailto:estoreslimite@hotmail.com)  
[www.estoreslimite.pt](http://www.estoreslimite.pt)